

Retail Price Guide &  
**QUICK SHIP STOCKING PROGRAM**

└ 1" x 1" T-Rail Sets

○ 20mm • 3/4" Pole Sets

○ ⊕ 28mm • 1 1/8" Pole Sets



Forest Group USA has partnered with Busche and Vion to bring you this exciting collection of decorative hardware engineered and manufactured in Germany.

All components are conveniently stocked in our Cartersville, Georgia facility and ready to ship to you today.

 **Made**  
 **in**  
 **Germany**

*All shortages, damages or problems must be reported within 10 days of receipt of goods. All returns must be approved prior to returning. No returns accepted after 30 days of shipment or for custom orders.*

*Also, please note that exact finish color may vary slightly due to the process involved.*

*\*Ripplefold is a registered trademark of Kirsch.*



	Component	Material	Finish	Part No.	Price ea.
	T-SECTION RAIL 1" x 1" x 1/8" standard length of 19'	aluminum	● satin aluminum	B919-08	\$ 19.10/ft
	SUSPENSION BRACKET wall bracket for T-Rail	aluminum	● satin aluminum	B11240-80-08	\$ 120.80
	GLIDER, round with eyelet and secondary ring clip for T-Rail	aluminum	● satin aluminum	B11245-08	\$ 18.80
	DRAPERY DIVIDER, round with eyelet and secondary ring clip for T-Rail	aluminum	● satin aluminum	B11247-08	\$ 25.00

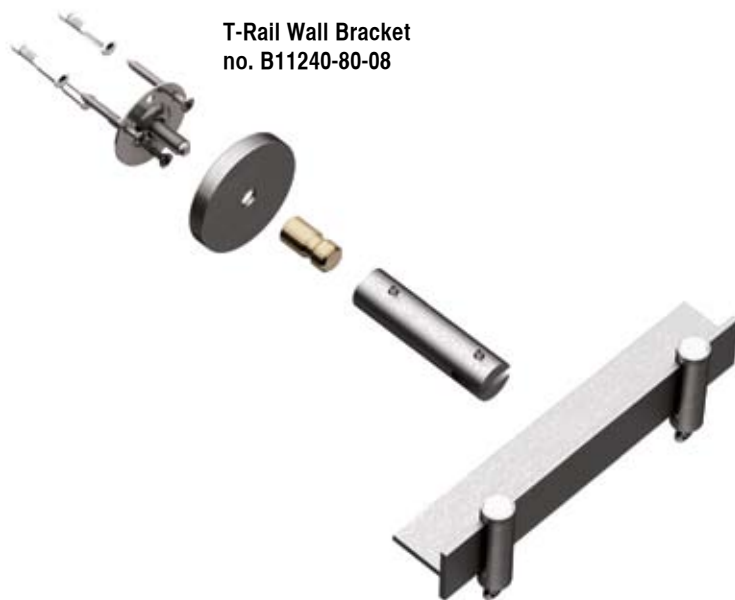







Component	Material	Finish	Part No.	Price ea.
	brass cased steel	polished chrome	B801-20-22	\$ 18.30/ft
	brass cased steel	satin brass	-24	\$ 14.10/ft
	brass cased steel	satin nickel	-29	\$ 15.20/ft
	brass cased steel	bronze matte	-70	\$ 24.40/ft
	brass	polished chrome	B124020-22	\$ 30.00
	brass	satin brass	-24	\$ 25.00
	brass	satin nickel	-29	\$ 30.00
	brass	bronze matte	-70	\$ 35.00
	brass	polished chrome	B3357-22	\$ 97.50
	brass	satin brass	-24	\$ 85.00
	brass	satin nickel	-29	\$ 97.50
	brass	bronze matte	-70	\$ 105.00
	brass	polished chrome	B690-20-22	\$ 122.50
	brass	satin brass	-24	\$ 110.00
	brass	satin nickel	-29	\$ 122.50
	brass	bronze matte	-70	\$ 130.00
	brass	polished chrome	B3363-22	\$ 120.00
	brass	satin brass	-24	\$ 105.00
	brass	satin nickel	-29	\$ 120.00
	brass	bronze matte	-70	\$ 127.50
	brass	polished chrome	B11950-20-22	\$ 102.50
	brass	satin brass	-24	\$ 95.00
	brass	satin nickel	-29	\$ 102.50
	brass	bronze matte	-70	\$ 112.50
	brass	polished chrome	B11952-20-22	\$ 155.00
	brass	satin brass	-24	\$ 142.50
	brass	satin nickel	-29	\$ 155.00
	brass	bronze matte	-70	\$ 167.50
	brass	polished chrome	B122020-22	\$ 55.00
	brass	satin brass	-24	\$ 47.50
	brass	satin nickel	-29	\$ 55.00
	brass	bronze matte	-70	\$ 62.50
	brass	polished chrome	B125620-22	\$ 6.30
	brass	satin brass	-24	\$ 6.00
	brass	satin nickel	-29	\$ 6.00
	brass	bronze matte	-70	\$ 6.80
	brass	polished chrome	B122920-22	\$ 122.50
	brass	satin brass	-24	\$ 115.00
	brass	satin nickel	-29	\$ 122.50
	brass	bronze matte	-70	\$ 132.50



Component	Material	Finish	Part No.	Price ea.
<p>Smooth TUBE 16'</p>	brass-cased steel	polished chrome	B801-28-22	\$ 21.30/ft
	brass-cased steel	satin brass	-24	\$ 16.80/ft
	brass-cased steel	satin nickel	-29	\$ 20.60/ft
	brass-cased steel	bronze matte	-70	\$ 29.70/ft
<p>Finial ENDCAP Available for H-Rail</p>	brass	polished chrome	B124028-22	\$ 35.00
	brass	satin brass	-24	\$ 30.00
	brass	satin nickel	-29	\$ 35.00
	brass	bronze matte	-70	\$ 40.00
	brass	black	-59	\$ 35.00
<p>Finial RIVA Available for H-Rail</p>	brass	polished chrome	B3356-22	\$ 165.00
	brass	satin brass	-24	\$ 147.50
	brass	satin nickel	-29	\$ 165.00
	brass	bronze matte	-70	\$ 175.00
	brass	black	-59	\$ 165.00
<p>Finial PESCARA Available for H-Rail</p>	brass	polished chrome	B690-22	\$ 197.50
	brass	satin brass	-24	\$ 172.50
	brass	satin nickel	-29	\$ 197.50
	brass	bronze matte	-70	\$ 207.50
	brass	black	-59	\$ 197.50
<p>Finial ALASSIO Available for H-Rail</p>	brass	polished chrome	B3362-22	\$ 200.00
	brass	satin brass	-24	\$ 182.50
	brass	satin nickel	-29	\$ 200.00
	brass	bronze matte	-70	\$ 210.00
	brass	black	-59	\$ 200.00
<p>Bracket SINGLE</p>	brass	polished chrome	B11950-28-22	\$ 162.50
	brass	satin brass	-24	\$ 150.00
	brass	satin nickel	-29	\$ 162.50
	brass	bronze matte	-70	\$ 175.00
<p>Bracket DOUBLE</p>	brass	polished chrome	B11952-28-22	\$ 225.00
	brass	satin brass	-24	\$ 207.50
	brass	satin nickel	-29	\$ 225.00
	brass	bronze matte	-70	\$ 237.50
<p>Bracket RECESS</p>	brass	polished chrome	B122028-22	\$ 70.00
	brass	satin brass	-24	\$ 62.50
	brass	satin nickel	-29	\$ 70.00
	brass	bronze matte	-70	\$ 77.50
<p>Ring W/ EYELET &amp; PLASTIC INSERT</p>	brass	polished chrome	B125630-22	\$ 9.30
	brass	satin brass	-24	\$ 8.80
	brass	satin nickel	-29	\$ 8.80
	brass	bronze matte	-70	\$ 9.80
<p>Tube CONNECTOR For use with Poles and H-Rail</p>	brass	polished chrome	B122928-22	\$ 147.50
	brass	satin brass	-24	\$ 140.00
	brass	satin nickel	-29	\$ 147.50
	brass	bronze matte	-70	\$ 157.50

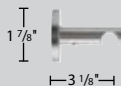
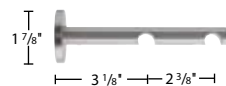
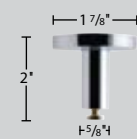

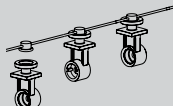
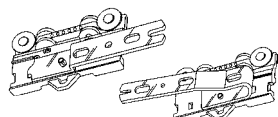
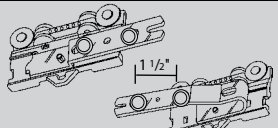
Finials for H-Rail are pictured on page 4.

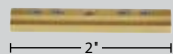
Component	Material	Finish	Part No.	Price ea.
 H-Rail SYSTEM 19'	aluminum	polished chrome	B808-28-22	\$ 32.80/ft
	aluminum	satin brass	-24	\$ 18.30/ft
	aluminum	satin nickel	-29	\$ 20.60/ft
	aluminum	bronze matte	-70	\$ 18.30/ft
	aluminum	black	-59	\$ 20.60/ft
 Bracket SINGLE	brass	polished chrome	B11670-22	\$ 100.00
	brass	satin brass	-24	\$ 95.00
	brass	satin nickel	-29	\$ 100.00
	brass	bronze matte	-70	\$ 110.00
	brass	black	-59	\$ 100.00
 Bracket DOUBLE	brass	polished chrome	B11672-22	\$ 132.50
	brass	satin brass	-24	\$ 122.50
	brass	satin nickel	-29	\$ 132.50
	brass	bronze matte	-70	\$ 142.50
	brass	black	-59	\$ 132.50
 Bracket CEILING	brass	polished chrome	B11873-50-22	\$ 80.00
	brass	satin brass	-24	\$ 75.00
	brass	satin nickel	-29	\$ 80.00
	brass	bronze matte	-70	\$ 90.00
	brass	black	-59	\$ 80.00
 Carrier BALL BEARING	plastic	white	52000-25	\$ 0.42
 Carrier CONNECTED SNAP For Ripplefold*	plastic	60% fullness, 2 5/8" OC spacing	2101-25	\$ 0.57
		80% fullness, 2 3/8" OC spacing	2102-25	
		100% fullness, 2 1/8" OC spacing	2100-25	
		120% fullness, 1 7/8" OC spacing	2109-25	
 Master Carrier MULTIFUNCTIONAL	plastic/steel	Overlap	52502-25	\$ 4.51
		Underlap 1 1/2" OC spacing	52504-25	
 Master Carrier FOR RIPPLEFOLD*	plastic/steel	Overlap	52502-25a	\$ 5.49
		Underlap 1 1/2" OC spacing	52504-25a	
 Drapery DIVIDER	plastic	white	B899-2-00	\$ 0.65
 Rail CONNECTOR	brass	brass	B899-3-00	\$ 14.80



# 28 mm • 1 1/8" Poles



Component	Material	Finish	Part Number	Price/ea.
<b>TUBE</b> 1 1/8" diameter, 19' length	Stainless Steel	stainless steel	V800-28-116	\$20.60/ft
	Aluminum	gold	-109	\$18.30/ft
	Aluminum	bronze	-132	\$18.30/ft

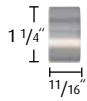

<b>END CAP</b> for 1 1/8" diameter Tube and H-Rail	Stainless Steel	stainless steel	V283000-116	\$25.00
	Aluminum	gold	-109	\$28.80
	Aluminum	bronze	-132	\$28.80

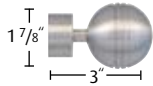

<b>GEO-NOTCHED BALL</b> for 1 1/8" diameter Tube and H-Rail	Stainless Steel	stainless steel	V283021-116	\$100.00
	Aluminum	gold	-109	\$107.50
	Aluminum	bronze	-132	\$107.50

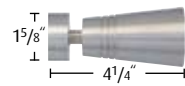

<b>GEO-NOTCHED TRUNCATED CONE</b> for 1 1/8" diameter Tube and H-Rail	Stainless Steel	stainless steel	V283020-116	\$100.00
	Aluminum	gold	-109	\$107.50
	Aluminum	bronze	-132	\$107.50

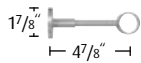

<b>WALL BRACKET GEO, SINGLE</b> 4 7/8" extension, for tubes	Stainless Steel	stainless steel	V284125-116	\$87.50
	Aluminum	gold	-109	\$100.00
	Aluminum	bronze	-132	\$100.00



<b>TUBE SOCKET GEO</b> to install tube with GEO H-Rail bracket	Stainless Steel	stainless steel	V287007-116	\$30.00
	Aluminum	gold	-109	\$35.00
	Aluminum	bronze	-132	\$35.00



<b>RECESS BRACKET</b> for 1 1/8" diameter Tube and H-Rail	Stainless Steel	stainless steel	V287001-116	\$62.50
	Aluminum	gold	-109	\$70.00
	Aluminum	bronze	-132	\$70.00

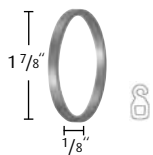

<b>FLAT DRAPERY RING</b> Includes secondary ring clip	Stainless Steel	stainless steel	V225728-116	\$3.08
	Aluminum	gold	-109	\$3.38
	Aluminum	bronze	-132	\$3.38

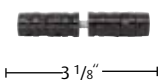

<b>TUBE CONNECTOR</b> for 1 1/8" diameter tubes does not swivel	Plastic	black	V83028-116	\$22.50
			V83028-000	\$22.50

# 28 mm • 1 1/8" H-Rails

Finials for H-Rail are pictured on page 7.

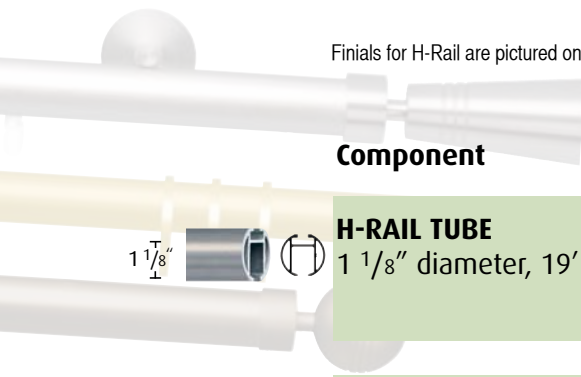

Component	Material	Finish	Part Number	Price/ea.
<b>H-RAIL TUBE</b> 1 1/8" diameter, 19' length	Stainless Steel	stainless steel	V808-28-116	\$20.60/ft
	Aluminum	gold	-109	\$18.30/ft
	Aluminum	bronze	-132	\$18.30/ft



<b>CEILING BRACKET</b> for H-Rail	Stainless Steel	stainless steel	V164915-116	\$31.30
	Aluminum	gold	-109	\$35.00
	Aluminum	bronze	-132	\$35.00

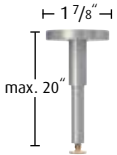

<b>CEILING BRACKET</b> for H-Rail, extension 2" - 20"	Stainless Steel	stainless steel	V164995-116	\$125.00
	Aluminum	gold	-109	\$135.00
	Aluminum	bronze	-132	\$135.00

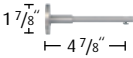

<b>WALL BRACKET GEO, SINGLE</b> 4 7/8" extension, for H-rails	Stainless Steel	stainless steel	V284425-116	\$62.50
	Aluminum	gold	-109	\$75.00
	Aluminum	bronze	-132	\$75.00

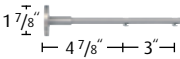

<b>WALL BRACKET GEO, DOUBLE</b> 4 7/8" - 7 7/8" extension, for H-rails	Stainless Steel	stainless steel	V285500-116	\$75.00
	Aluminum	gold	-109	\$87.50
	Aluminum	bronze	-132	\$87.50



<b>BALL BEARING CARRIER</b> for H-Rails	Plastic	white	52000-25	\$0.42
--	---------	-------	----------	--------

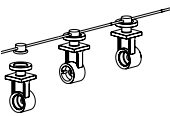

<b>CONNECTED SNAP CARRIER</b> for Ripplefold*/Roll Pleat	60% fullness, 2 5/8" OC spacing	2101-25	\$0.57
	80% fullness, 2 3/8" OC spacing	2102-25	
	100% fullness, 2 1/8" OC spacing	2100-25	
	120% fullness, 1 7/8" OC spacing	2109-25	

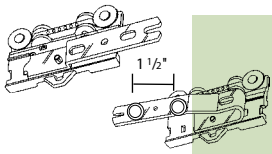

<b>MASTER CARRIERS</b> Multifunctional 1 1/2" OC spacing For Ripplefold*	Plastic/Steel	Overlap	52502-25	\$4.51
		Underlap	52504-25	\$4.51
	Plastic/Steel	Overlap w/snap	52502-25a	\$5.49
		Underlap w/snap	52504-25a	\$5.49



<b>DRAPERY DIVIDER</b> for H-Rails	Plastic	white	V799-2-00	\$0.55
---------------------------------------	---------	-------	-----------	--------

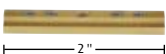

<b>RAIL CONNECTOR</b> for H-Rails	Brass	brass	V899-3-00	\$14.80
--------------------------------------	-------	-------	-----------	---------



**1 1/8" "GEO" - Tube  
V284125**



**1 1/8" "GEO" - Channel glide system  
V284425 & V285500**



**Ceiling Bracket, 2"-20" projection  
V164995**



**1 1/8" "GEO" - Tube Socket  
V287007**



**Recess bracket V287001,  
B122020 & B122028**



**Ceiling bracket, 5/8" projection  
V164915**



## You can order sample boards for your showroom

SBB1= 3/4" Pole in Satin Brass

1@24" - B801-20-24  
 2 - B690-20-24  
 2 - B11950-20-24  
 3 - B125620-24

SBB2= 3/4" Double Pole in Polished Chrome

2@24" - B801-20-22  
 2 - B3363-22  
 2 - B124020-22  
 2 - B11952-20-22  
 6 - B125620-22

SBB3= 1-1/8" Pole in Satin Nickel

1@24" - B801-28-29  
 2 - B3356-29  
 2 - B11950-28-29  
 3 - B125630-29

SBB4= 1-1/8" H-Rail in Bronze

1@24" - B808-28-32  
 2 - B3362-32  
 2 - B11670-32  
 3 - 52000-25  
 1 - 52504-25  
 1 - B899-2-00

SBB5= 1-1/8" Double H-Rail in Satin Nickel

2@24" - B808-28-29  
 2 - B690-29  
 2 - B124028-29  
 2 - B11672-29  
 2@10 - 2100-25  
 2 - 52504-25a  
 2 - B899-2-00

SBB6= 1-1/8" Pole in Polished Chrome

1@24" - B801-28-22  
 2 - B690-22  
 2 - B11950-28-22  
 3 - B125630-22

SBB7= 1" T-Rail in Aluminum

1@24" - B919-08  
 2 - B11240-80-08  
 3 - B11245-08  
 2 - B11247-08

SBV1= 1-1/8" Pole in Stainless Steel

1@24" - V800-28-116  
 2 - V283021-116  
 2 - V284125-116  
 3 - V225728-116

SBV2= 1-1/8" Double H-Rail in Gold

2@24" - V808-28-109  
 2 - V283021-109  
 2 - V283000-109  
 2 - V285500-109  
 6 - 52000-25  
 2 - 52504-25  
 2 - V799-2-00

SBV3= 1-1/8" Double Pole/H-Rail in Bronze

1@24" - V808-28-132  
 1@24" - V800-28-132  
 2 - V283020-132  
 2 - V283000-132  
 2 - V285500-132  
 2 - V287007-132  
 3 - V225728-132  
 10 - 2100-25  
 1 - 52504-25a  
 1 - V799-2-00

Sample Board - \$100.00

B0008-00 Sample Board Rails - \$75.00 ea.

B0009-00 Display Stand - \$600.00 ea.





For a distributor in your area go to  
[www.forestgroup.com](http://www.forestgroup.com)

---

# **FOREST**

DRAPERY HARDWARE

DISTRIBUTED BY:

All prices subject to change without notice.